

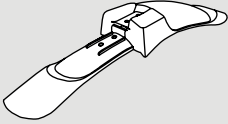

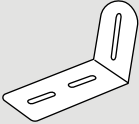



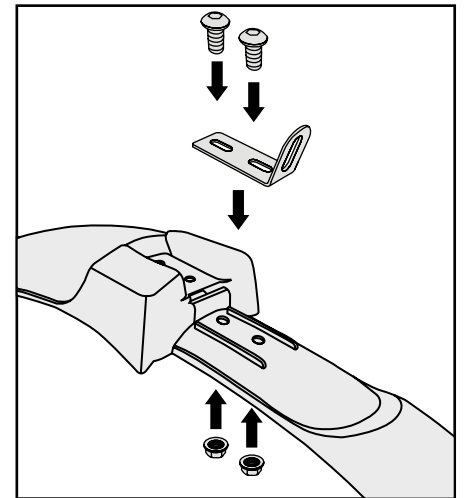

Bergsteiger Broome: assembly instructions

	1x mudguard (front)
	1x fork bridge
	2x M5x10 screw
	2x M5 nut

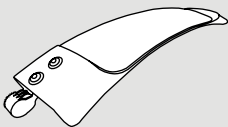
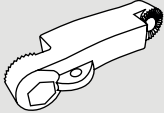
1. Front mudguard

To assemble the front mudguard the front mudguard, the triple clamp, the bolts and the appropriate nuts. and the appropriate nuts. Place the fork bridge with the two recesses on the recess of the mudguard. Screw the triple clamp with the screws and nuts at the bottom. Finally, you can mount the mudguard on the fork of the Mount the mudguard to the fork of the bike.



	1x mudguard (rear)
	1x connector
	1x bracket
	1x plastic ring
	2x rotating ring
	2x M5x30 hexagon head screw
	3x M5 nut
	1x M5x30 screw

2. Rear mudguard

To assemble the rear mudguard, use all the remaining enclosed parts. Insert the plastic ring into the bracket from above. Then screw the mudguard together with the connecting piece and the bracket. To do this, use the hexagonal bolts with the turning wheels and nuts. Determine the angle of the connecting piece on the mudguard and then tighten the screws with the rotary wheels. Now open the bracket with the plastic ring so far that it can be placed around the seat post. Finally, screw the bracket with the screw and the last nut in the desired location.

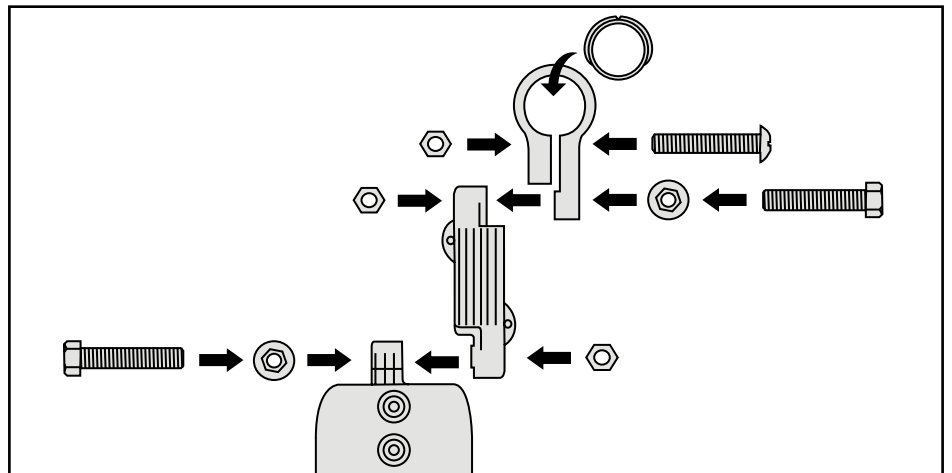

Note dynamo:

In order for the bike light to illuminate, turn on the dynamo and also set the switch on the light to ON.

 We wish you a good ride and a lot of fun with your mountain bike!

